

# Aluminum Blinds

## Instruction manual

size:400Lx300Wx212Hcm

---

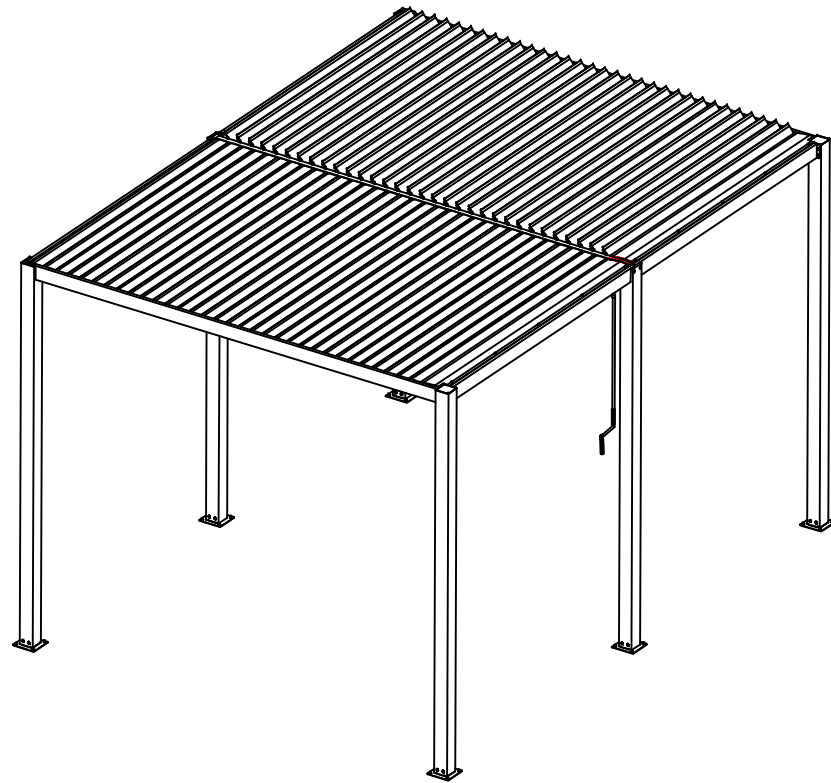

**BP-QRP43N**

18/07/2020

### **IMPORTANT**

These instructions must be read carefully before starting assembly. Make sure all parts are found  
The cartons shall be packed in the correct type and quantity as stated in the list in the corresponding description on each page.

Follow the steps in the order shown in these instructions.

All screws of the main frame must be tightened before the blade assembly is completed.

Please keep these instructions in a safe place for future reference

## SAFETY ADVICE

- We strongly recommend the use of work gloves during assembly.
- Do not attempt to assemble the Aluminum Blinds in windy or wet conditions.
- Do not touch overhead power cables with the aluminum profiles.
- Always wear shoes and safety goggles when working with extruded aluminum.
- Dispose of all plastic bags safely-keep them out of reach of small children.
- The Aluminum Blinds must be positioned and fixed on a flat level surface.
- Do not lean against or push the Aluminum Blinds during construction.
- Keep children away from the assemble area.
- Do not position your Aluminum Blinds in an area exposed to excessive wind.
- Do not attempt to assemble this Aluminum Blinds if you are tired ,have taken drugs or alcohol or if you are prone to dizzy spells.
- If using a step ladder or power tools ensure that you follow the manufacturer's safety advice.
- Hot items such as recently used grills, blowtorches etc.must not be stored in the Aluminum carport.
- Ensure there are no hidden pipes or cables in the ground before inserting the pegs.

## GENERAL ADVICE

- This is a multi-part assembly, Allow at least 90-120 minutes for assembly.
- Selecting a site-choose a sunny level position away from overhanging trees.
- If you are fixing your Aluminum Blinds directly to a solid concrete foundation use the predrilled holes in the metal base supplied.
- The component parts should be checked and laid out close to hand.
- Keep all small parts(screws etc)in a bowl so they do not get lost.
- Keep roof clear from snow and leaves.

## CARE & MAINTENANCE

- When your Aluminum Blinds needs cleaning, use a mild detergent solution and risen with cool clean water.
- Do NOT use acetone, abrasive cleaners or other special detergents to clean the clear panels.

## TOOLS & EQUIPMENT REQUIRED

### Protective Equipment:

- 1.Helmet
- 2.Glove
- 3.Long Sleeve Cotton Overalls
- 4.Emergency Medicine Cabinet
- 5.Eye Shield



### Measure (metric):

- 1.The Tape (5 m)
- 2.Angle Square
- 3.Level Meter



### INSTALLATION TOOL:

- 1.Triangle Stairs≈1.5m Height
- 2.Spanner 14mm (Ratchet Wrench is better)
- 3.Spanner 12-14mm (Install the expansion screw)
- 4.Hexagon wrench 3,4,5mm
5. Electric screwdriver + 3,4,5mm hexagon wrench (recommended)
- 6.Wooden Mallet
- 7.Marking Pen
- 8.Silicon
- 9.Percussion bit(10mm and 12mm)
- 10.Cross slotted screwdriver

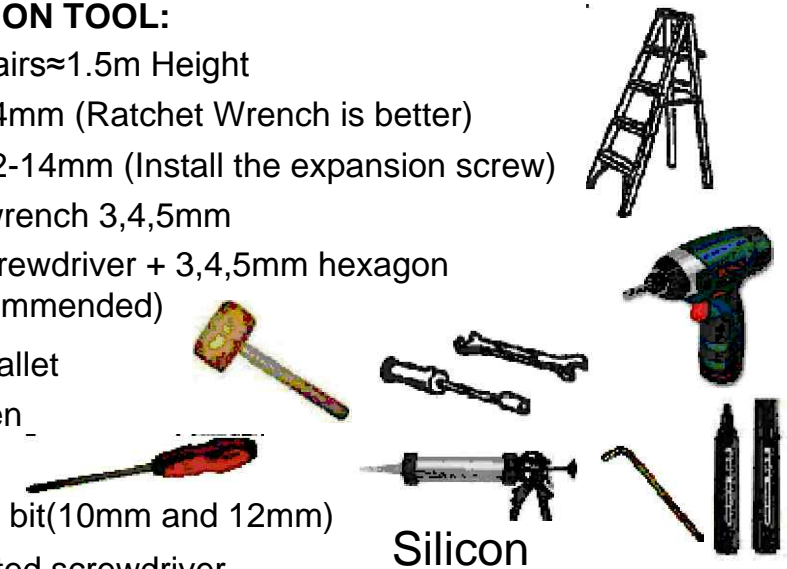

Silicon

## PRODUCT SIZE

Make sure a good installation location





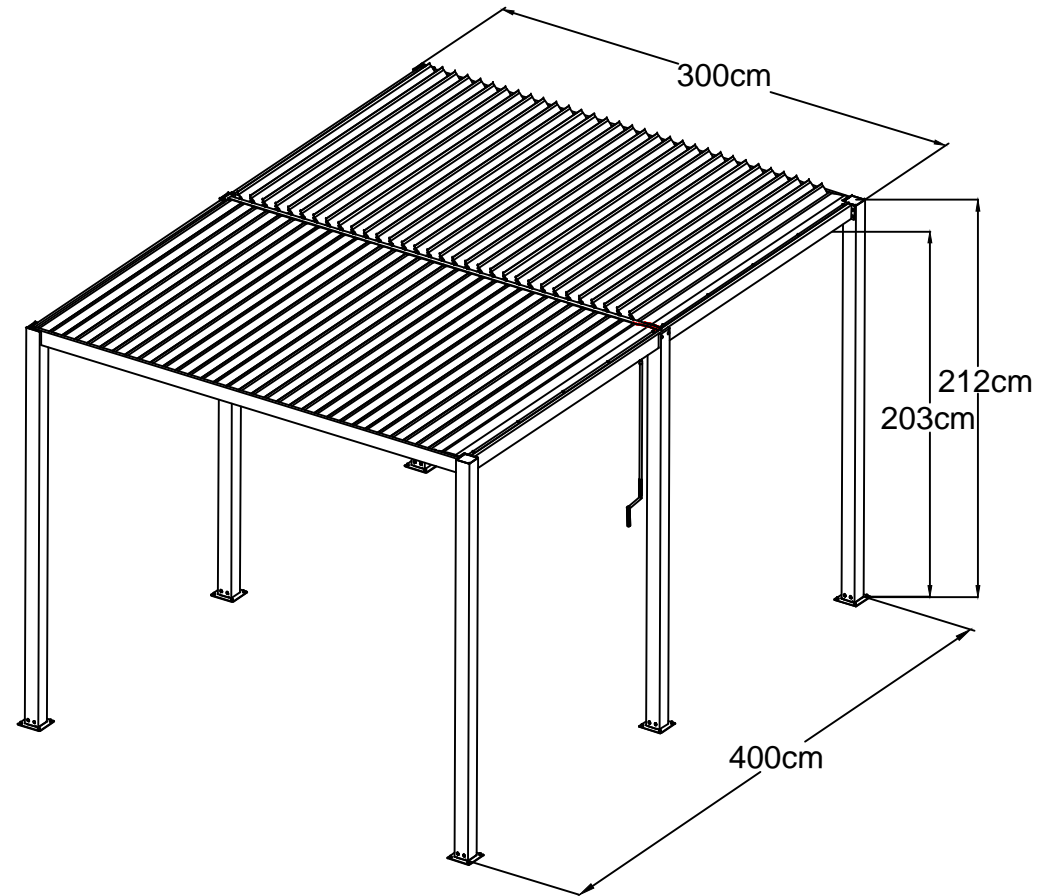







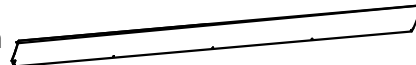

















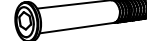
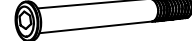











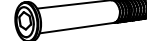
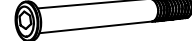











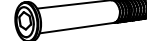
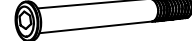











## OTHER CAUTIONS

1. 4-5 people required, one is for measuring & taking marks to ensure the installation dimension ,the second person is responsible for the installation and the last one do as assistant and assure the safety.
2. Firstly, make sure the blinds is strong enough for installation. A brick concrete structures is the best choice.
3. High-power electric tools are required, ensure the normal work of them and highly pay attention to electric safety.
4. Be careful when using the kind of blunt tools, like hammer.
5. Wearing long sleeve cotton overalls,gloves and helmet during installation and wear safety glasses when using power tools .
6. Don't look up when Working in high position, or the drop screws may hurt your eyes and suffocation causing accidentally when falling into your mouth.
7. No climbing, No standing on the Blinds to avoid falling down.
8. If injuries immediately, using the first-aid kit to stop bleeding, bind up, In case of emergency, taken immediately to a nearby medical institutions



# PARTS LIST

## MAIN PROFILE PARTS

NO.	Qty.			NO.	Qty.																																																														
Ⓐ	1	 2120mm		⒩	1	 1943mm																																																													
Ⓑ	1	 2120mm		⒪	1	 1943mm																																																													
Ⓒ	1	 2120mm		⒫	64	 1939mm																																																													
Ⓓ	1	 2130mm		<table border="1"> <thead> <tr> <th>NO.</th> <th>Qty.</th> <th colspan="2">SPARE PARTS</th> </tr> </thead> <tbody> <tr> <td>①</td> <td>6</td> <td>150X150</td> <td></td> </tr> <tr> <td>②</td> <td>2</td> <td></td> <td></td> </tr> <tr> <td>③</td> <td>1</td> <td></td> <td></td> </tr> <tr> <td>④</td> <td>2</td> <td>78X78X81.5</td> <td></td> </tr> <tr> <td>⑤</td> <td>10</td> <td>M5X15</td> <td></td> </tr> <tr> <td>⑥</td> <td>21</td> <td>M6x20</td> <td></td> </tr> <tr> <td>⑦</td> <td>24</td> <td>M8x15</td> <td></td> </tr> <tr> <td>⑧</td> <td>8</td> <td>M8x30</td> <td></td> </tr> <tr> <td>⑨</td> <td>2</td> <td>M8x35</td> <td></td> </tr> <tr> <td>⑩</td> <td>2</td> <td>M8x55</td> <td></td> </tr> <tr> <td>⑪</td> <td>2</td> <td>M8</td> <td></td> </tr> <tr> <td>⑫</td> <td>24</td> <td>M8x60</td> <td></td> </tr> <tr> <td>⑬</td> <td>24</td> <td>M8</td> <td></td> </tr> <tr> <td>⑭</td> <td>2</td> <td></td> <td></td> </tr> </tbody> </table>				NO.	Qty.	SPARE PARTS		①	6	150X150		②	2			③	1			④	2	78X78X81.5		⑤	10	M5X15		⑥	21	M6x20		⑦	24	M8x15		⑧	8	M8x30		⑨	2	M8x35		⑩	2	M8x55		⑪	2	M8		⑫	24	M8x60		⑬	24	M8		⑭	2		
NO.	Qty.	SPARE PARTS																																																																	
①	6	150X150																																																																	
②	2																																																																		
③	1																																																																		
④	2	78X78X81.5																																																																	
⑤	10	M5X15																																																																	
⑥	21	M6x20																																																																	
⑦	24	M8x15																																																																	
⑧	8	M8x30																																																																	
⑨	2	M8x35																																																																	
⑩	2	M8x55																																																																	
⑪	2	M8																																																																	
⑫	24	M8x60																																																																	
⑬	24	M8																																																																	
⑭	2																																																																		
Ⓔ	1	 2130mm																																																																	
Ⓕ	1	 2130mm																																																																	
Ⓖ	1	 1964mm																																																																	
Ⓗ	1	 1964mm																																																																	
Ⓘ	1	 2873mm																																																																	
Ⓝ	1	 2915mm																																																																	
Ⓚ	1	 2873mm																																																																	
Ⓛ	1	 1909mm																																																																	
Ⓜ	1	 2059mm																																																																	

# Install schematic diagram of Alu.frames

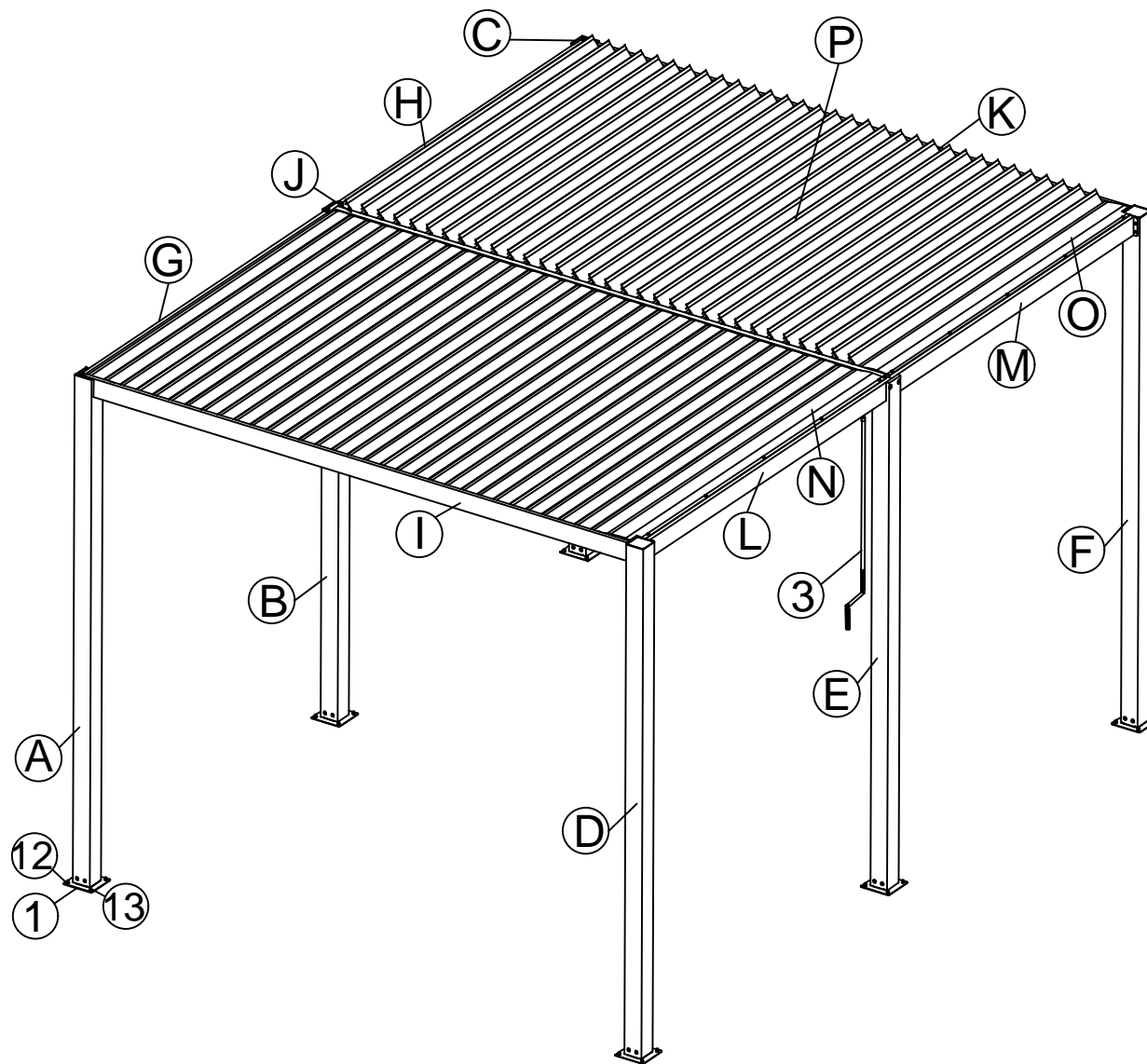

# Usage mode

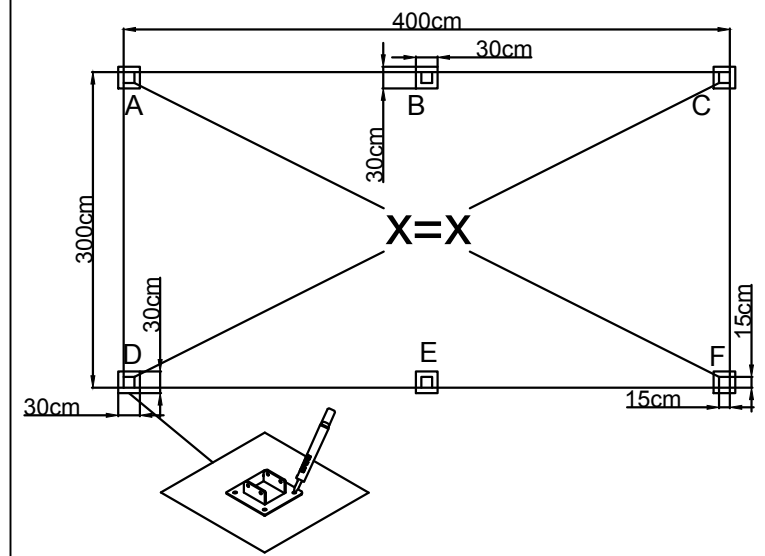
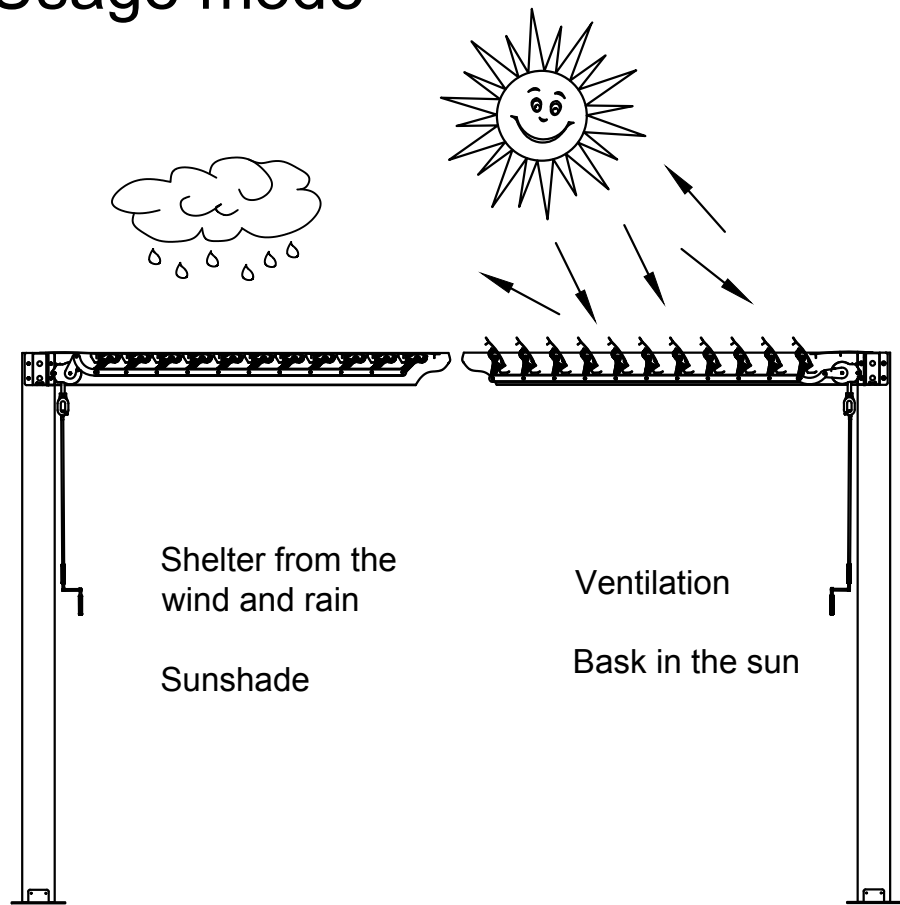

For the stability of product installation, please make sure to pour 30x30x30cm concrete at the bottom of each column

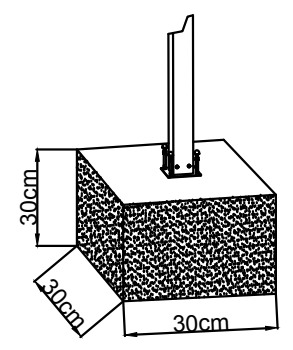

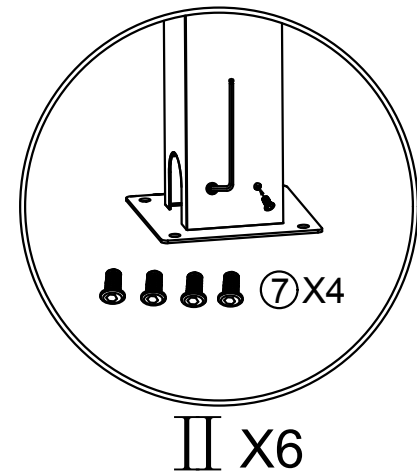
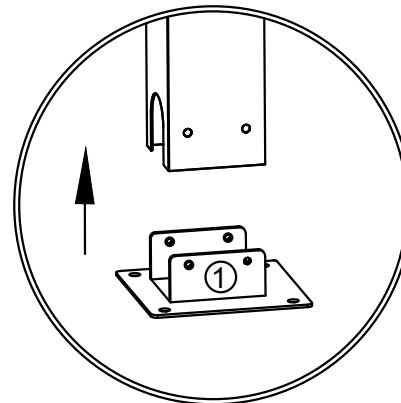
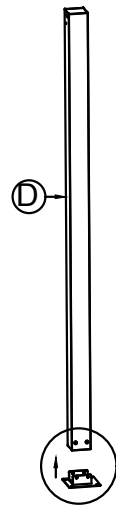
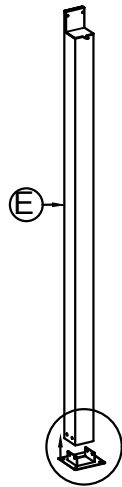
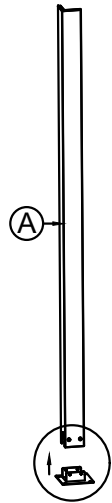
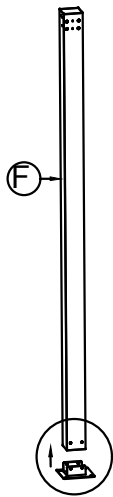
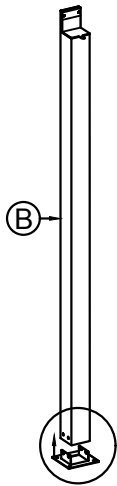
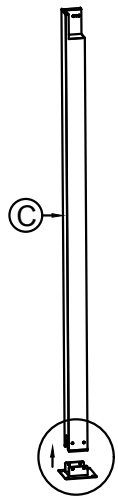
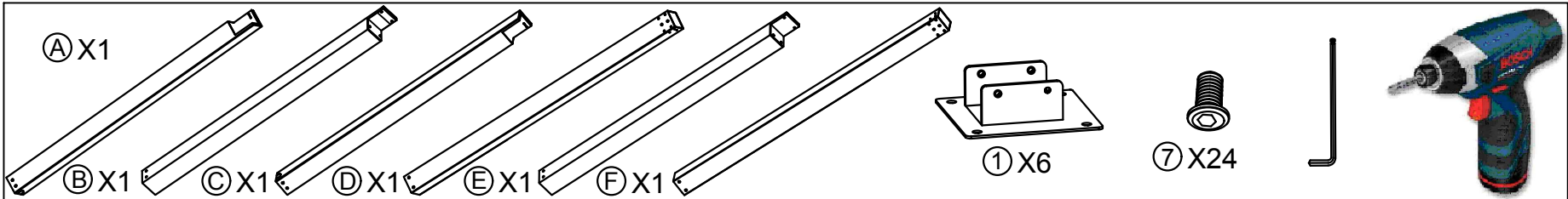

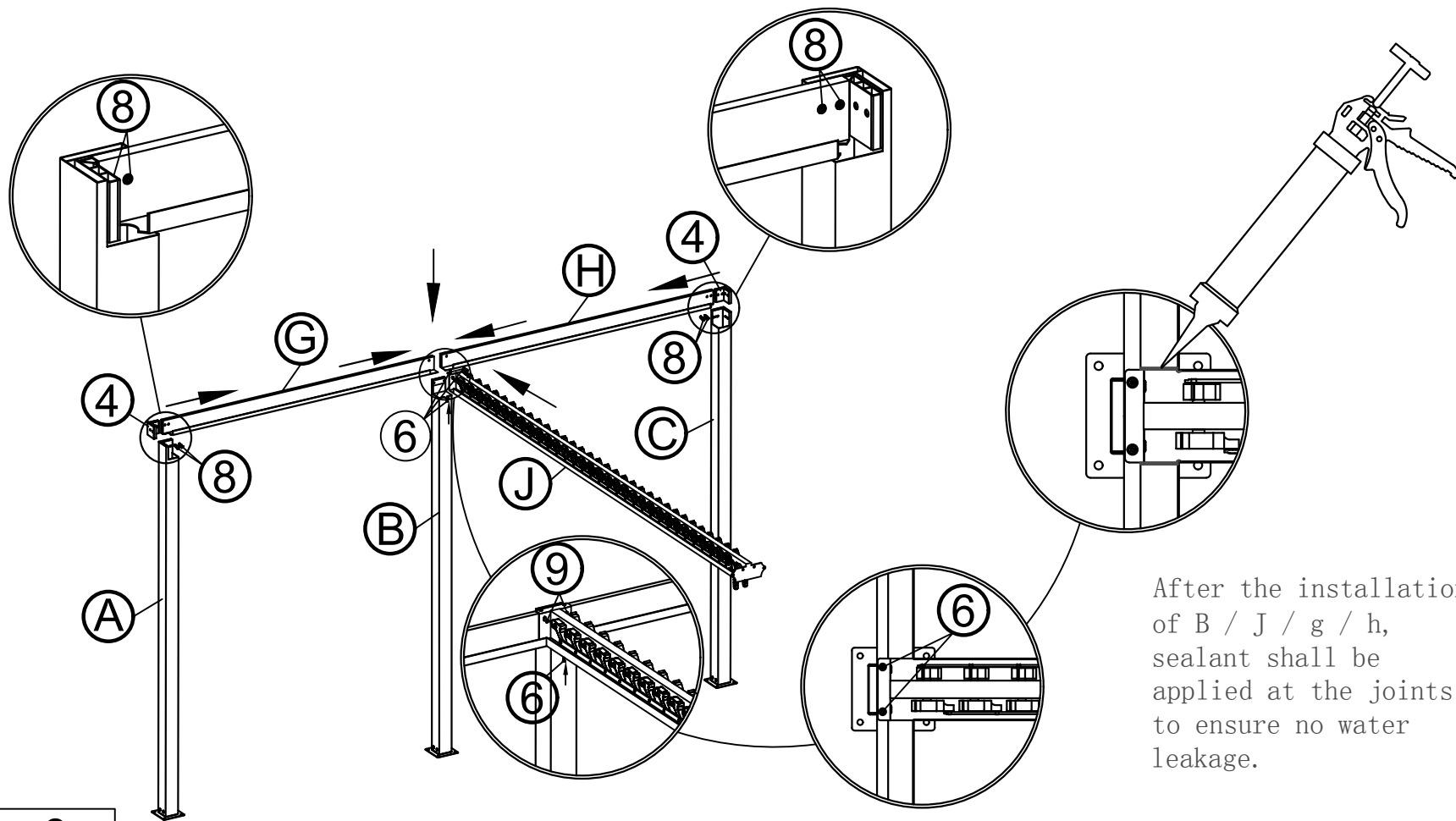
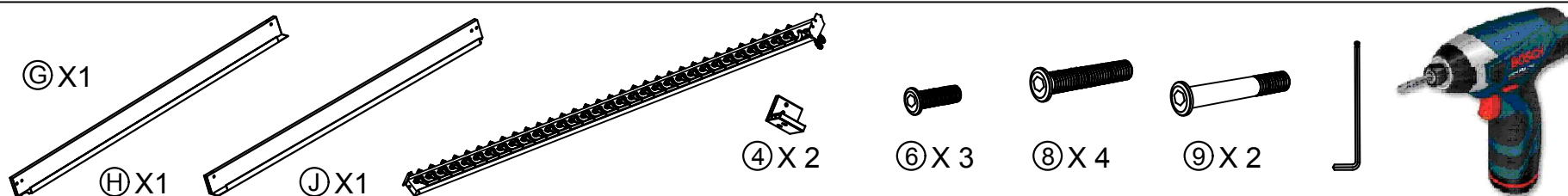

After the installation of B / J / g / h, sealant shall be applied at the joints to ensure no water leakage.



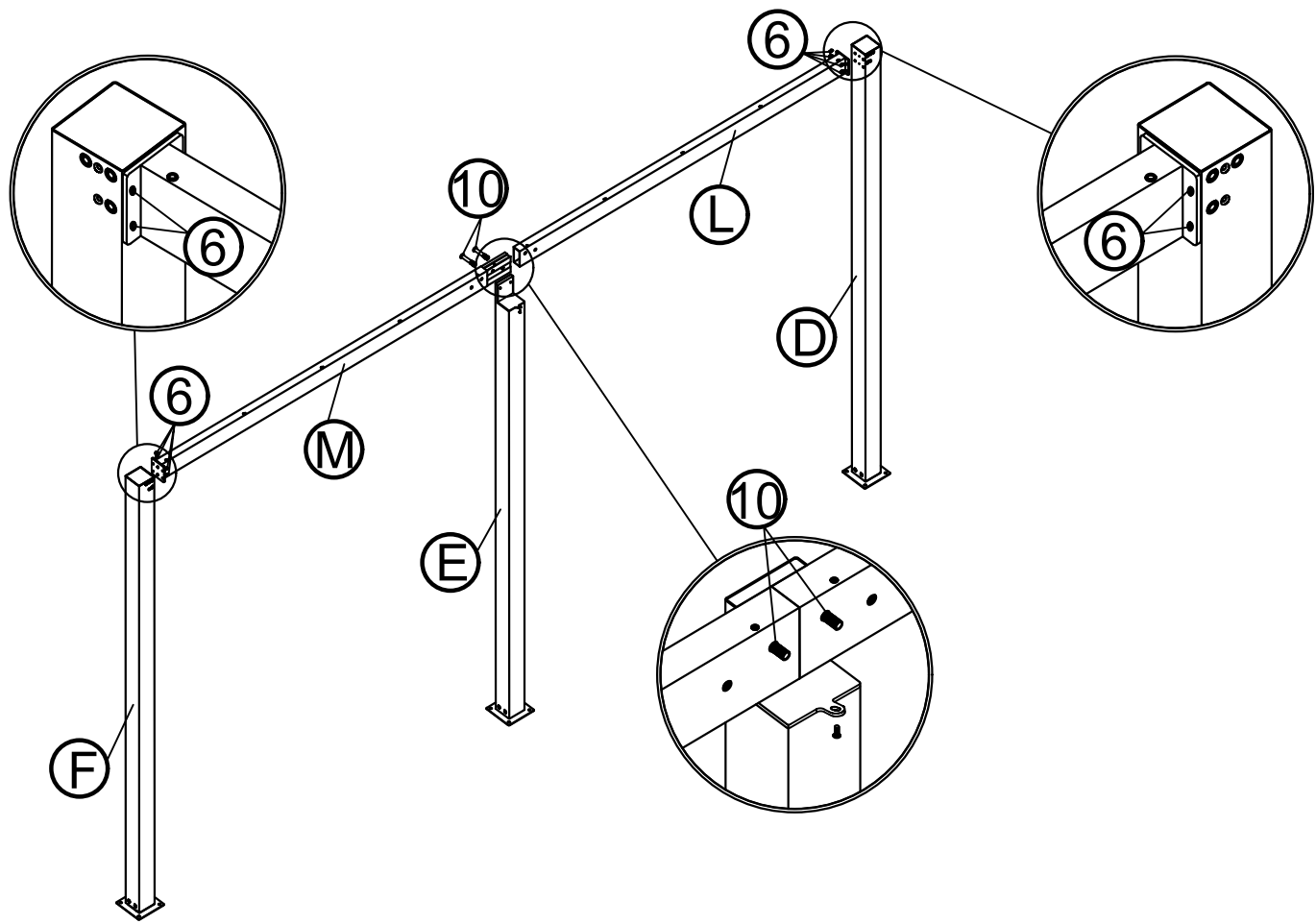
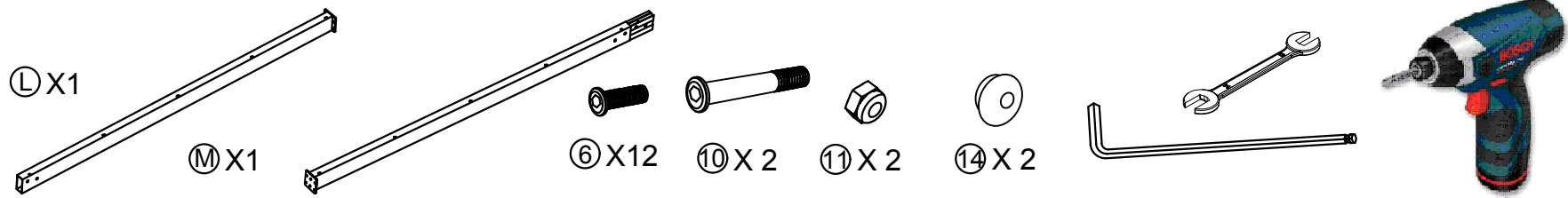

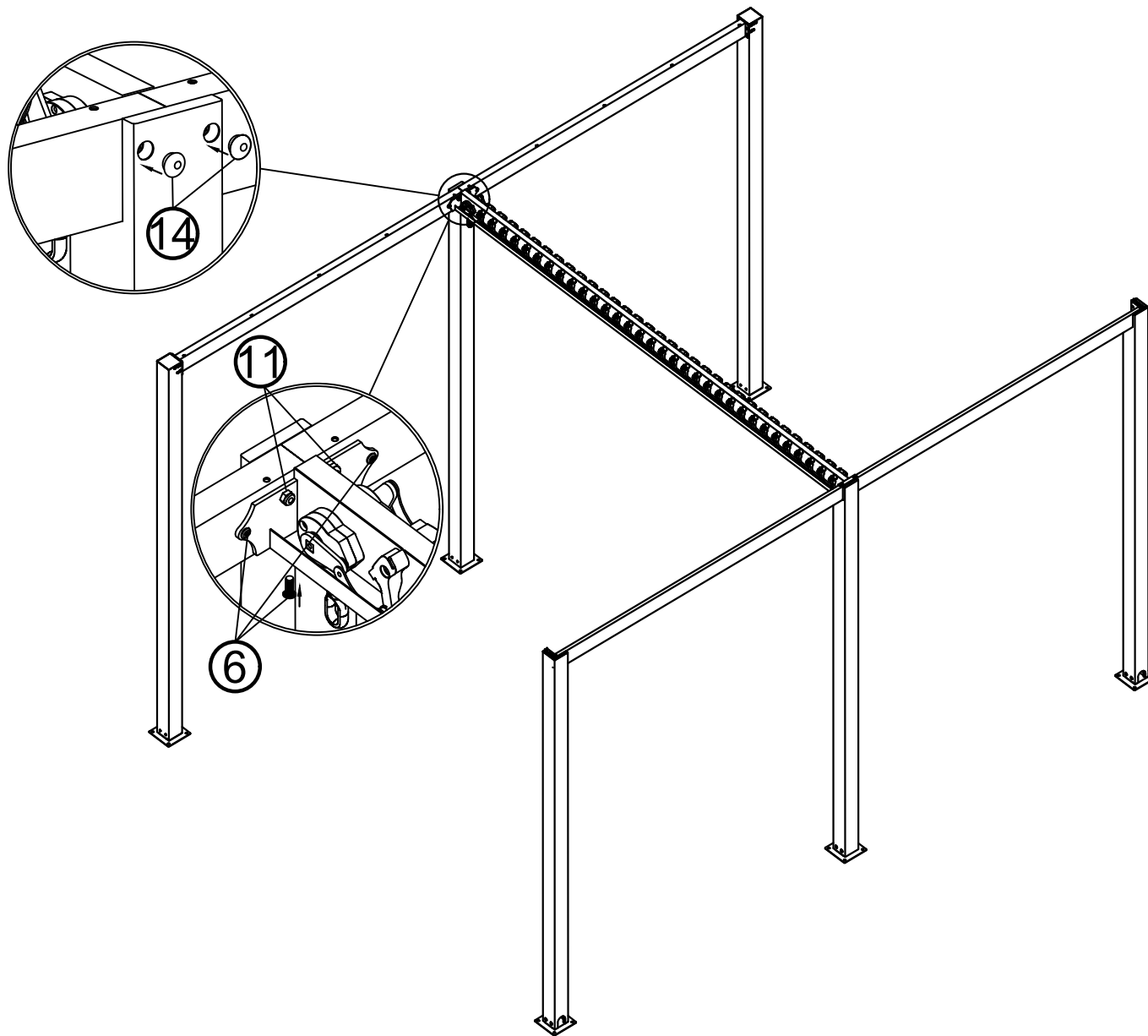

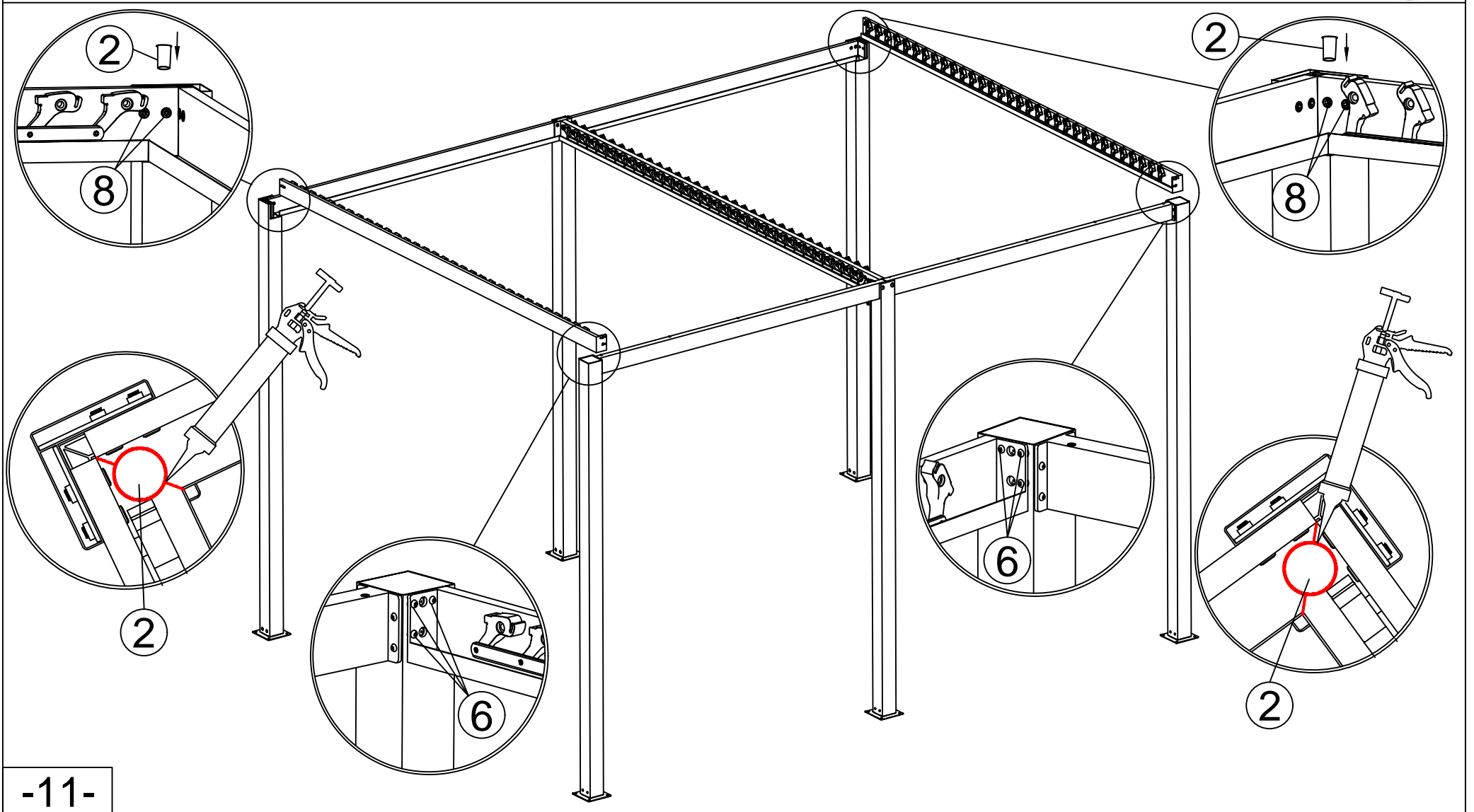
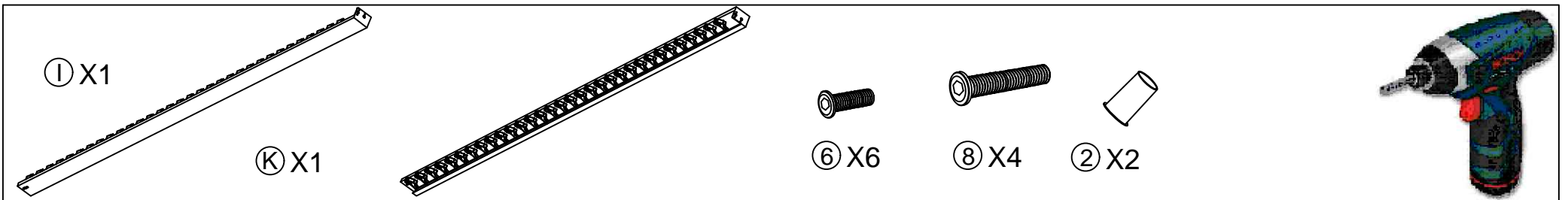

Ⓟ X64

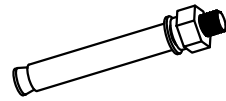
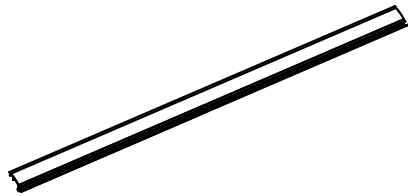

Ⓜ X24

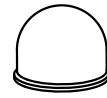

Ⓝ X24

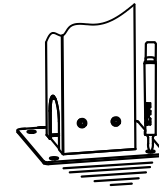
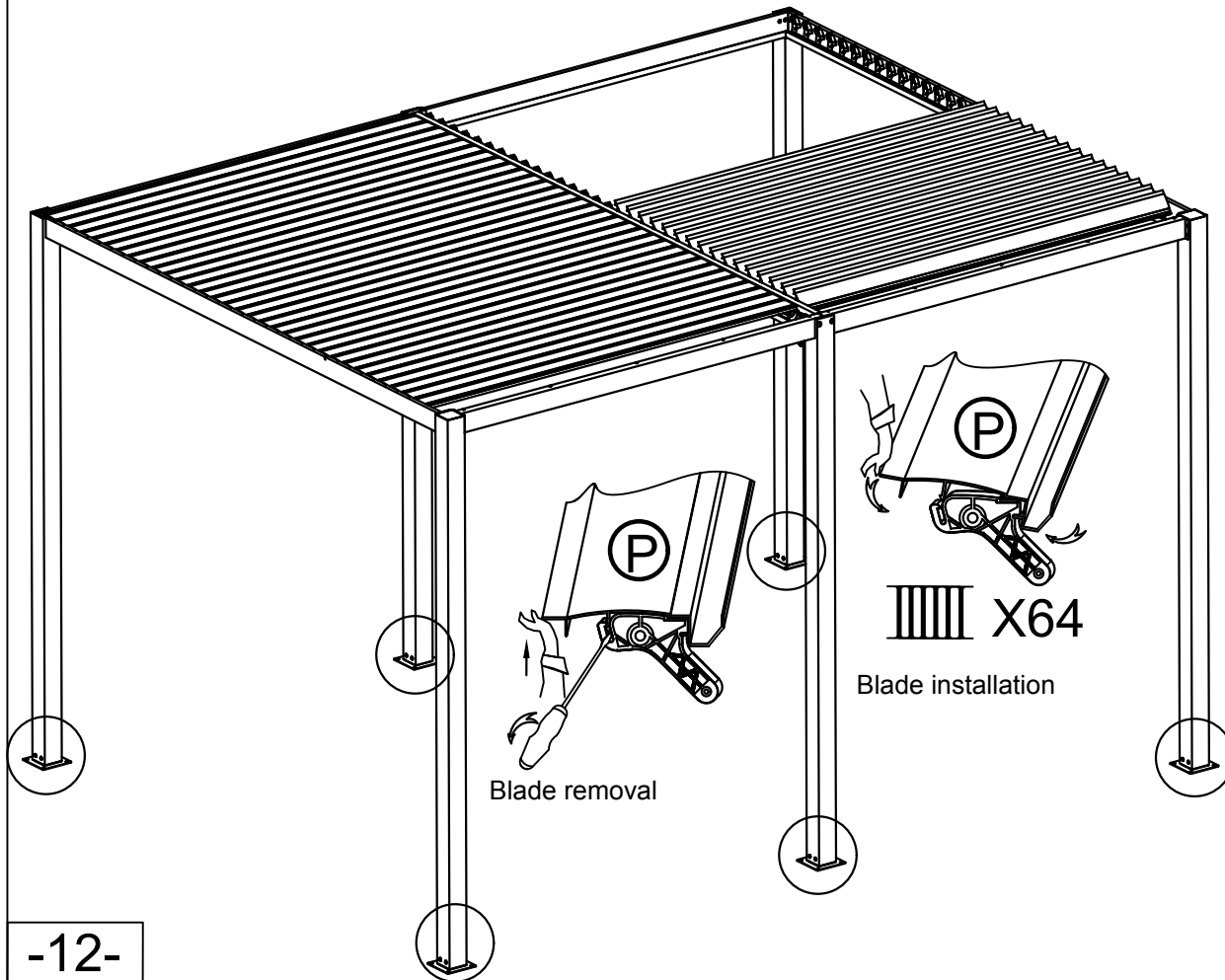
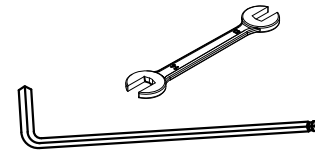

I X6

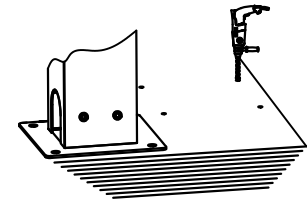

II X6

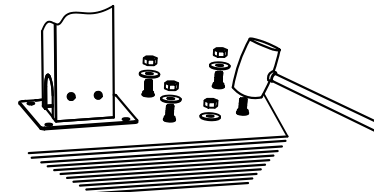

III X6

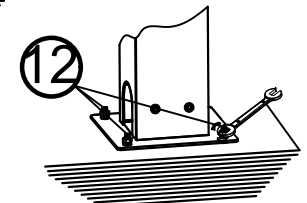

Ⓜ

III X6

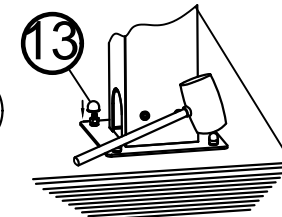

Ⓝ

III X6

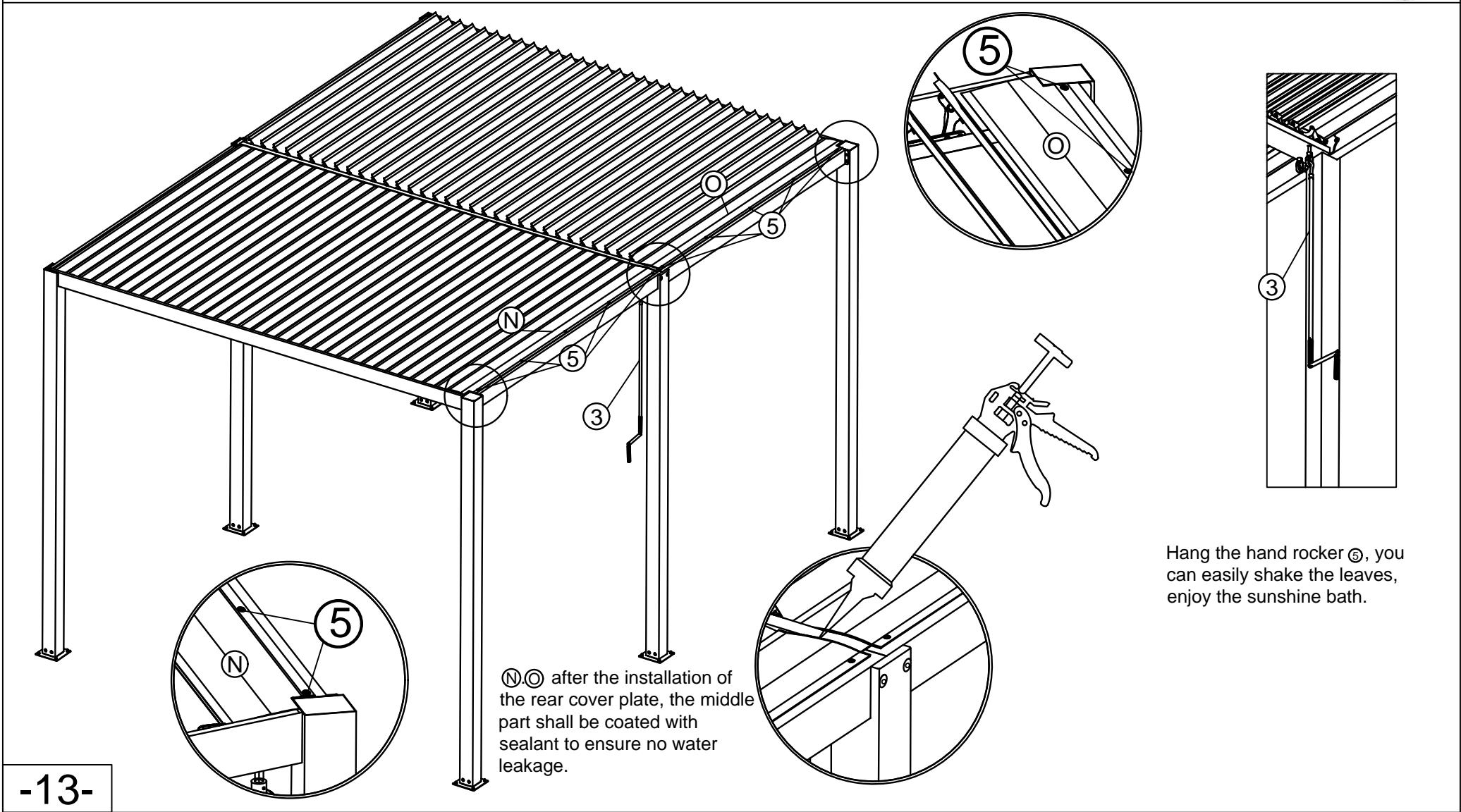
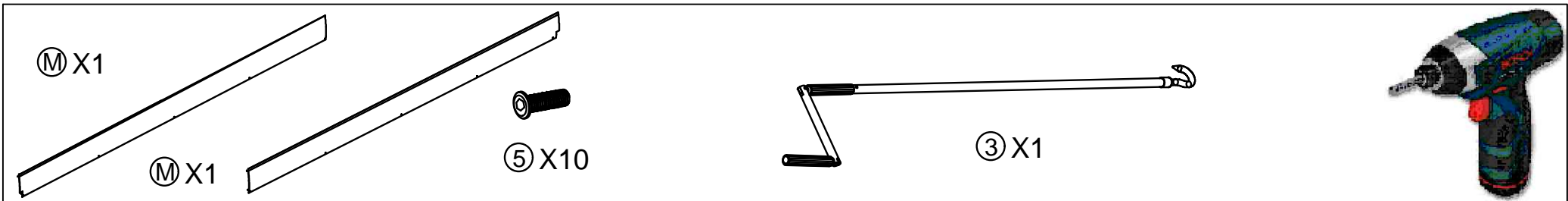

(N) (O) after the installation of the rear cover plate, the middle part shall be coated with sealant to ensure no water leakage.

Hang the hand rocker (3), you can easily shake the leaves, enjoy the sunshine bath.